

**NEW**

# LINEO RANGE

In-line mixed flow fans





**VORTICE S.p.A.** is now part of a multinational group, the **VORTICE GROUP**, which operates through its own companies or local distributors in over 90 countries worldwide and has a rich product portfolio that guarantees air quality and climate comfort. The headquarters of VORTICE S.p.A are in Tribiano (Milan).



The VORTICE GROUP also includes:

[ 1 ]  
**VORTICE UK Ltd**, English branch of VORTICE S.p.A. established in 1977 and based in Burton on Trent.

[ 2 ]  
**VORTICE INDUSTRIAL**, created in 2010 through the acquisition of Loran srl, based in Isola della Scala (VR - Italy).

[ 3 ]  
**VORTICE Ventilation System**, a company inaugurated in 2013 with headquarters in Changzhou, China.

[ 4 ]  
**VORTICE Latam**, based in San José in Costa Rica, born in 2012.

[ 5 ]  
**CASALS** historic Spanish brand of VENTILACIÓN INDUSTRIAL IND. S.L., based in Sant Joan de les Abadesses, Girona, acquired in 2019.



# INDEX

Page 05

## LINEO RANGE features and strengths

Page 12

### LINEO QUIET ES RANGE

In-line mixed flow fans equipped with EC Brushless motors



Page 18

### LINEO QUIET RANGE

In-line mixed flow fans equipped with AC motors

Page 24

## LINEO and LINEO ES RANGE features and strengths

Page 28

### LINEO RANGE

In-line mixed flow fans equipped with AC motors

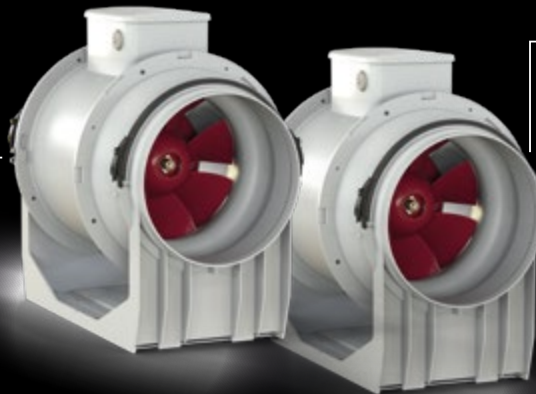

Page 34

### LINEO ES RANGE

In-line mixed flow fans equipped with EC Brushless motors

## Certifications

The LINEO range products are CE marked per the Directives and regulations listed below. They have IMQ certification for compliance with the safety and electromagnetic compatibility directives listed below.

- Relevant Directive and regulations for the CE Marking
- Machinery Directive (2006/42/CE)
  - Low Voltage Directive (2014/35/EU)
  - Electromagnetic Compatibility Directive (2014/30/EU)
  - Ecodesign Directive (2009/125/EC)
  - RoHS Directive (2011/65/EU)
  - WEEE Directive (2012/19/EU)
  - ERP Regulation No. 327/2011/EU - 1253/2014/EU

- Electrical safety regulations
- EN 60335-1
  - EN 60335-2-80
  - EN 62233
  - EN 60529

- Regulations associated with the Machinery Directive
- EN 60204-1
  - EN 12100
  - EN 12499
  - EN 13857

- Electromagnetic compatibility Regulations
- EN 55014-1
  - EN 55014-2
  - EN 61000-3-2
  - EN 61000-3-3

# LINEO RANGE

## In-line mixed flow fans

The LINEO range products are “mixed flow” fans specifically designed for horizontal or vertical installation in conduit for

VENTILATION OF RESIDENTIAL,  
COMMERCIAL OR INDUSTRIAL PREMISES.



They all have high levels of energy efficiency and meet the requirements of ERP Regulation 327/2011/EU ERP 1253/2014/EU and new versions proposed for implementation from 2022. The fans in the renewed LINEO range boast

HIGH PERFORMANCE, LOW ENERGY CONSUMPTION, LOW NOISE EMISSIONS AND EASE OF INSTALLATION AND MAINTENANCE

placing them at the top of the category.

The LINEO range products are characterised by technopolymer enclosures for increased fire resistance safety class E2, according to EN ISO 11925-2:2010 and have a high degree of protection against water (IPX5) the classification only applies to a properly installed product

## THE DESIGN

### CONSTRUCTION FEATURES COMMON TO THE RANGE

#### The design consists of the following:

- a central motor mount which encloses the fan motor unit and houses the wiring devices externally, in an easily reachable position;
- the main body, fixed to a pair of end supports arranged for connection to the suction and delivery pipes, which is designed to rotate on its own axis to facilitate the housing of the product in small spaces and its wiring through the contacts positioned on its external surface;

The ease with which it can be removed without altering the surrounding piping system, greatly speeds up and facilitates maintenance;

- the air flow rectifiers on the delivery side work in synergy with the upstream impeller, optimise the managed air flow, maximising performance and increasing efficiency, reducing the occurrence of vortices and minimising noise emissions;
- the mixed flow type impellers, combine the advantages of helical fans (high flow rates and flow around the axis of the impeller), with the high pressures of centrifugal fans; the directly coupled motors have shafts mounted on ball bearings, ensuring a virtually “maintenance free” operation;
- the timer in the T models allows the operation of the appliance to be programmed at maximum speed and ease at a range between 3' and 20', which can be set during installation.

### STRENGTHS:

- high-performance, top-of-the-range;
- easy maintenance. Each component allows easy connection and disconnection with the nearby elements, and easy access to the inner components (motor-impeller) and their replacement. In the case of silenced products, the sound absorbing shells refitted at the end of the maintenance process, restore the original sound performance under test conditions;
- the motors have a minimum guaranteed life in continuous operation at maximum speed and at maximum ambient temperature of 30,000 or 40,000 hours depending on the type;
- completeness of the range, designed to offer the ideal product to meet the specific requirements of the system in terms of performance, consumption, quiet operation, operating costs and purchase price.

# LINEO QUIET RANGE

In-line mixed flow fans

The **LINEO QUIET** range products are characterised by the use of a **sound-absorbing coating**, which is fully integrated in the outer casing and optimised to minimise environmental sound emissions.

**HIGH-LEVEL PERFORMANCE,  
AT THE TOP OF THE RANGE.**



NEW

**LINEO QUIET RANGE**

In-line mixed flow fans



because energy  
has to be....

**SAVED**

The impeller profiles,  
the flow rectifiers and ogival profile  
of the flow driver work in synergy with  
the upstream impeller optimise the  
managed air flow, maximising performance  
and increasing efficiency, reducing  
the occurrence of vortices and  
minimising noise  
emissions.

because silence  
has to be....

# BUILT

## IMPELLER

Designed to reach the ERP  
efficiency levels

## CO-MOULDED SHELL

Easily removable during maintenance  
without any effect on his sound  
dampening effect

## INLET NOZZLE

Dimensioned to sustain the product  
in the wall and ceiling installation

## DIVERGENT ELEMENT

It helps the impeller to increase  
the performance

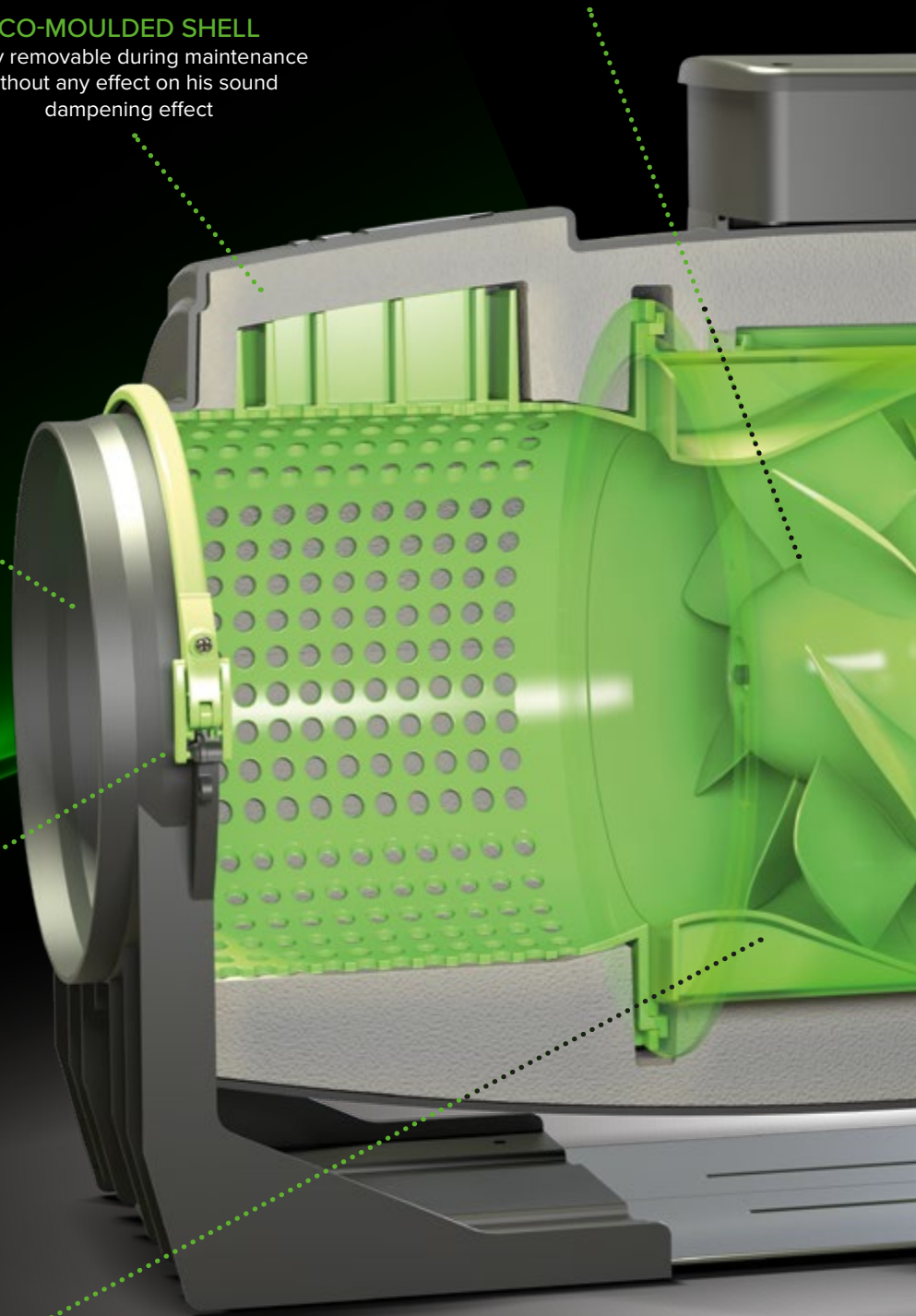



NEW

# LINEO QUIET RANGE

In-line mixed flow fans



## ELECTRIC BOX

Produced in a material granting electrical and fire resistance

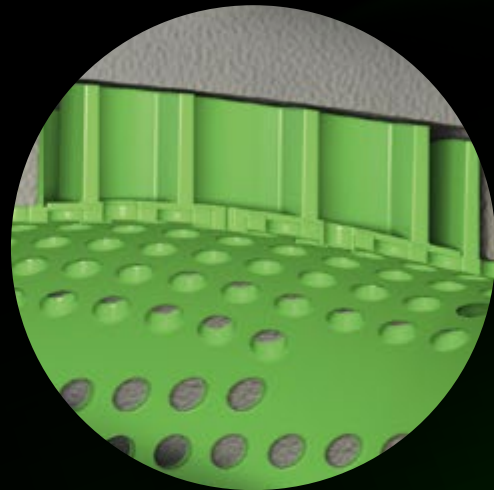

## HELMHOLTZ RESONATOR GROUP

Passive sound dampener used to decrease the noise levels at predetermined frequencies

## FLOW DRIVER

It corrects the airflow after the impeller and the rectifier, avoiding energy losses due to vortices

## CO-MOULDED SHELL

Easily removable during maintenance without any effect on his sound dampening effect

## RECTIFIER BLADES

Designed with the impeller to rectify the airflow and avoid flow problems on the downstream part of the product

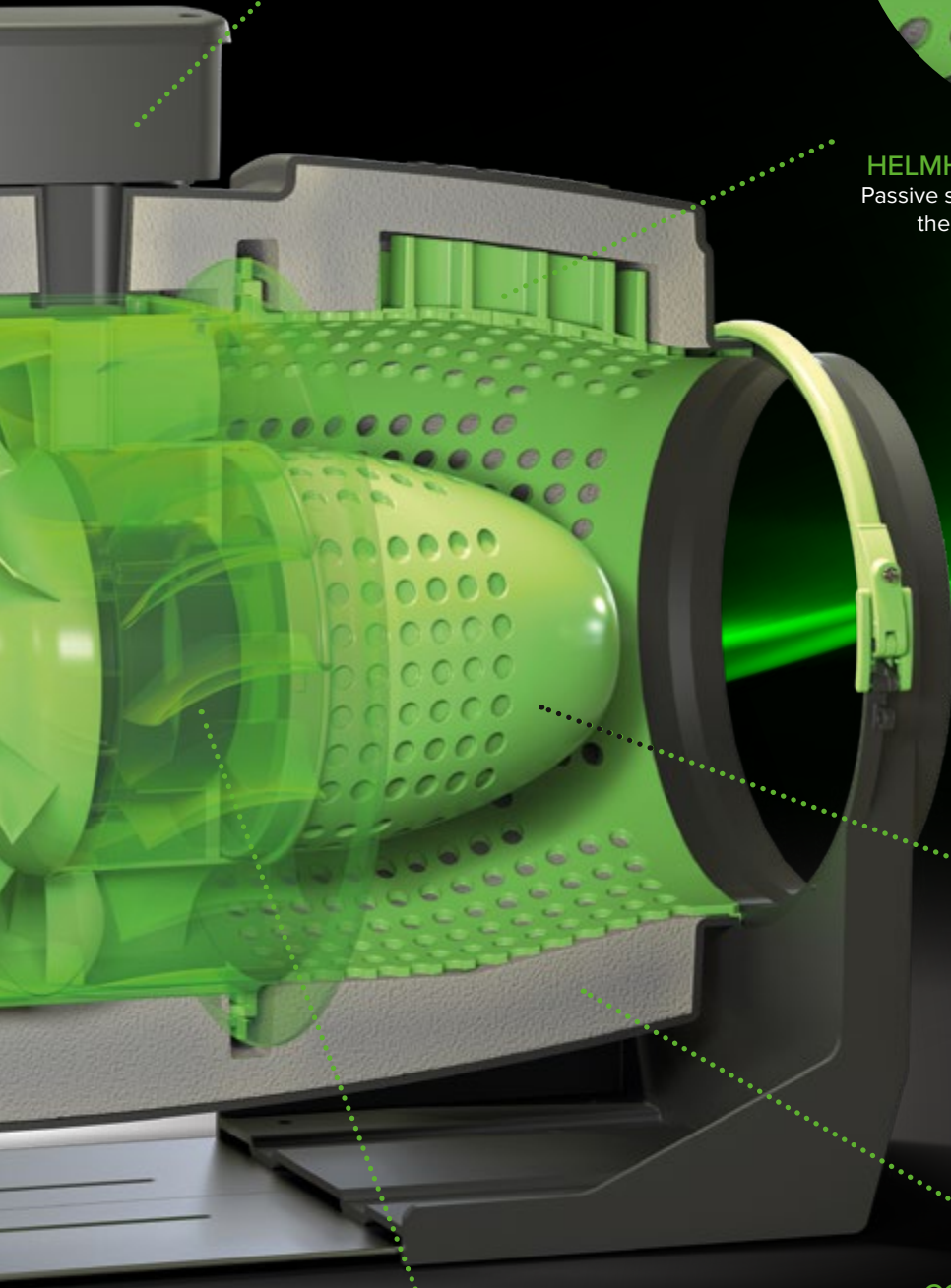

# LINEO QUIET ES RANGE

equipped with EC brushless motors

The products in the **LINEO QUIET ES** range differ from the corresponding versions of the LINEO QUIET range due to the use of electronically controlled brushless (low consumption) motors.



# LINEO QUIET RANGE

equipped with AC motors

The **LINEO QUIET** range products are fitted with traditional AC motors.



because environment  
has to be....

**SUSTAINED**





# LINEO QUIET ES RANGE NEW

In-line mixed flow fans equipped with EC Brushless motors

## TECHNICAL AND PERFORMANCE DATA - LINEO QUIET ES

Models	Code	V~50/60HZ	W		RPM	Max Airflow		Max Pressure		Max °C	KG
			4/6/8/10V	A		4/6/8/10V	l/s	mmH <sub>2</sub> O	Pa		
			4/6/8/10V	4/6/8/10V		4/6/8/10V	4/6/8/10V	4/6/8/10V	4/6/8/10V		
LINEO 100 QUIET ES	17170	220-240	6.2	0.09	1140	135	37.5	3.5	34.3	60	3,8
			8.3	0.12	1450	175	48.6	5.8	56.9		
			14.7	0.18	2050	250	69.4	11.4	111.8		
			23	0.26	2510	300	83.3	24.8	243.2		
LINEO 125 QUIET ES	17171	220-240	6.6	0.10	1080	180	50	3.3	32.4	60	3,6
			8.8	0.12	1340	225	62.5	5.6	54.9		
			16	0.18	1865	320	88.9	11	107.9		
			24	0.26	2210	380	105.6	23.7	232.4		
LINEO 150 QUIET ES	17172	220-240	7.7	0.11	1015	250	69.4	4.6	45.1	60	5,4
			10.6	0.14	1240	305	84.7	7.5	73.6		
			20	0.24	1700	430	119.4	14.7	107.9		
			31	0.34	2030	515	143.1	24.2	237.3		
LINEO 160 QUIET ES	17173	220-240	7.7	0.11	1010	250	69.4	4.5	44.1	60	5,2
			10.6	0.14	1245	315	87.5	7.5	73.6		
			19.7	0.23	1685	435	120.8	14.4	141.2		
			31	0.34	2035	525	145.8	23.9	234.4		
LINEO 200 QUIET ES	17174	220-240	15.2	0.18	1380	570	158.3	8.6	84.3	50	8,6
			25.3	0.27	1705	720	200	13.9	136.3		
			52.4	0.52	2245	945	262.5	22.9	224.6		
			88	0.78	2700	1145	318.1	33.6	329.5		
LINEO 250 QUIET ES	17175	220-240	20	0.19	1365	750	208,3	10,1	99,1	50	13,4
			35	0.28	1680	940	261,1	15,6	153		
			75	0.60	2250	1250	347,2	26,6	260,9		
			125	0.97	2680	1485	412,4	37,5	367,8		
LINEO 315 QUIET ES	17176	220-240	42	0,31	1260	1400	388,9	12,9	126,5	50	28,3
			72	0,51	1560	1730	480,6	19,5	191,2		
			155	1,10	2070	2300	638,9	33,8	331,5		
			220	1,52	2350	2630	730,6	38,7	379,5		

## SOUNDS LEVELS - LINEO QUIET ES

Calculated in free field conditions at 3 m distance

### SOUND LEVEL Lw dB (A)

Models	Code	INTAKE				SUPPLY				IRRADIATED			
		4V	6V	8V	10V	4V	6V	8V	10V	4V	6V	8V	10V
LINEO 100 QUIET ES	17170	64.8	72.4	77.5	79.1	64.5	73.2	75.6	79	38.1	46.2	46.5	47.9
LINEO 125 QUIET ES	17171	63.7	71	75.8	78.3	64.3	73.5	74.7	79.4	42.3	48.5	51	51.7
LINEO 150 QUIET ES	17172	65.5	72.1	75	76.9	66	72.8	75.6	76.7	40.7	45.8	49.6	50.8
LINEO 160 QUIET ES	17173	65.5	72.1	75	76.9	66	72.8	75.6	76.7	40.7	45.8	49.6	50.8
LINEO 200 QUIET ES	17174	74.8	80	82.6	84.7	72.4	77.6	80.5	83.6	49.9	54.4	56.9	59.1
LINEO 250 QUIET ES	17175	71.4	76.7	83.7	88,1	70,7	76,1	83	87,2	44,4	49,1	55,9	60
LINEO 315 QUIET ES	17176	82.6	85.7	88.3	89.1	73.3	80.6	82.2	84.5	55.9	62.3	64.7	65.3

### SOUND PRESSURE LP dB(A)

Models	Code	INTAKE				SUPPLY				IRRADIATED			
		4V	6V	8V	10V	4V	6V	8V	10V	4V	6V	8V	10V
LINEO 100 QUIET ES	17170	47.3	54.9	59.9	61.5	47	55.7	25.9	47	17.6	25.6	25.9	27.4
LINEO 125 QUIET ES	17171	46.1	53.4	58.3	60.8	46.8	56	57.2	61.9	21.8	28	30.4	31.3
LINEO 150 QUIET ES	17172	48	54.6	57.4	59.4	49	55.3	58.1	59.1	20.2	25.3	29.1	30.2
LINEO 160 QUIET ES	17173	48	54.6	57.4	59.4	49	55.3	58.1	59.1	20.2	25.3	29.1	30.2
LINEO 200 QUIET ES	17174	57.3	62.4	65.1	67.1	54.8	60.1	63	66.1	29.4	33.9	36.4	38.6
LINEO 250 QUIET ES	17175	53.9	59.2	66.1	70.5	52	58.6	65.5	69.7	23.8	28.6	35.4	39.5
LINEO 315 QUIET ES	17176	65.1	68.2	70.8	71.6	55.8	63.1	64.6	67	35.4	41.8	44.1	44.8

## DIMENSIONS - LINEO QUIET ES

Models	Code	A	B	C	Ø D	E	F	G	H	L	Ø M	N	VERSION
LINEO 100 QUIET ES	17170	210	294.6	639	97	130	235	135	120	67.5	5.5	320	A
LINEO 125 QUIET ES	17171	210	294.6	504.5	122	130	235	135	120	67.5	5.5	320	A
LINEO 150 QUIET ES	17172	232	320.6	685	147	145	261.5	170	132	85	5.5	360	A
LINEO 160 QUIET ES	17173	232	320.6	570	156.5	145	261.5	170	135	85	5.5	360	A
LINEO 200 QUIET ES	17174	322.5	417.6	625.5	194.5	195	363.5	190	120	155	5.5	510	B
LINEO 250 QUIET ES	17175	318	411.9	751.5	243	189.5	363.5	200	70	170	6.5	604.5	B
LINEO 315 QUIET ES	17176	415.5	557.8	940	307	234	441	309	110	255	8.5	780	C

### VERSION A

LINEO 100 QUIET ES - LINEO 125 QUIET ES - LINEO 150 QUIET ES - LINEO 160 QUIET ES

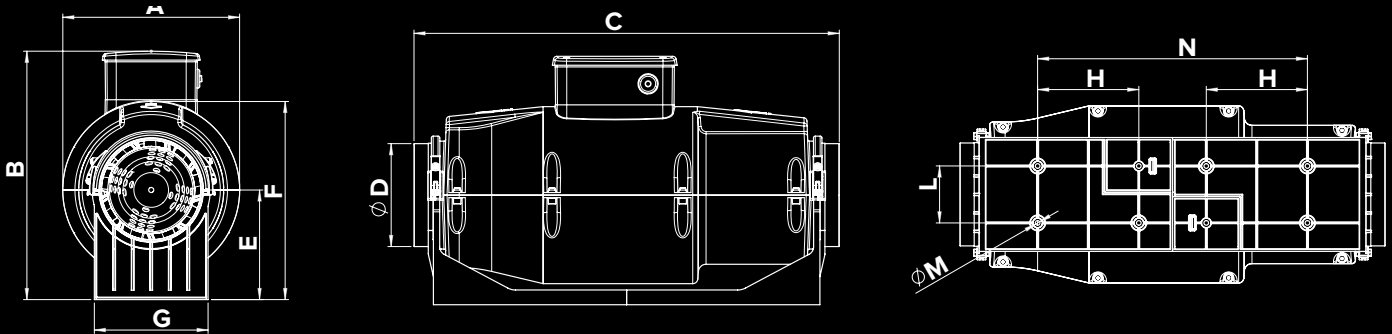

### VERSION B

LINEO 200 QUIET ES - LINEO 250 QUIET ES

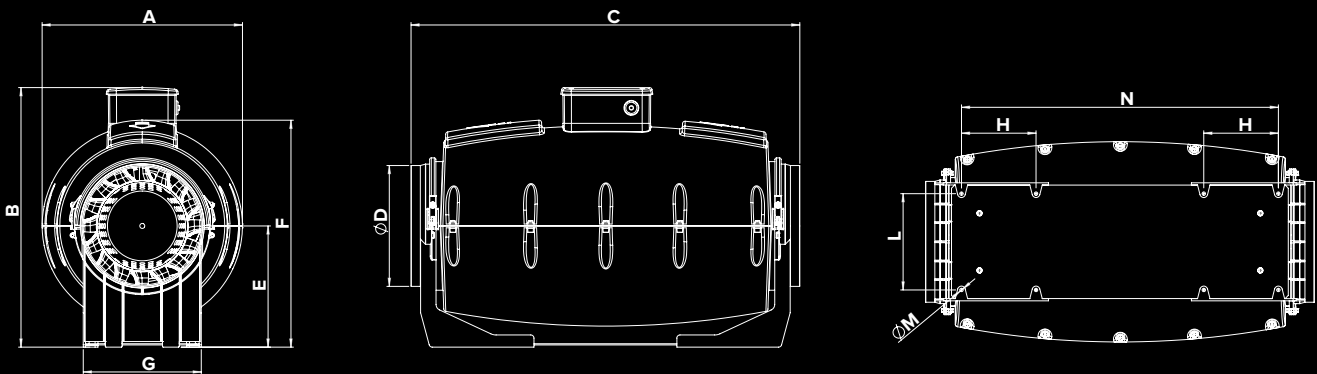

### VERSION C

LINEO 315 QUIET ES

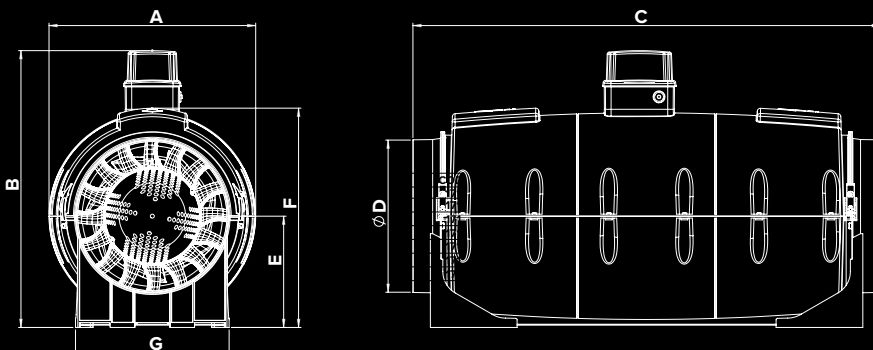



# LINEO QUIET ES RANGE NEW

In-line mixed flow fans equipped with EC Brushless motors

## PERFORMANCE AND ABSORPTION CURVES - LINEO QUIET ES

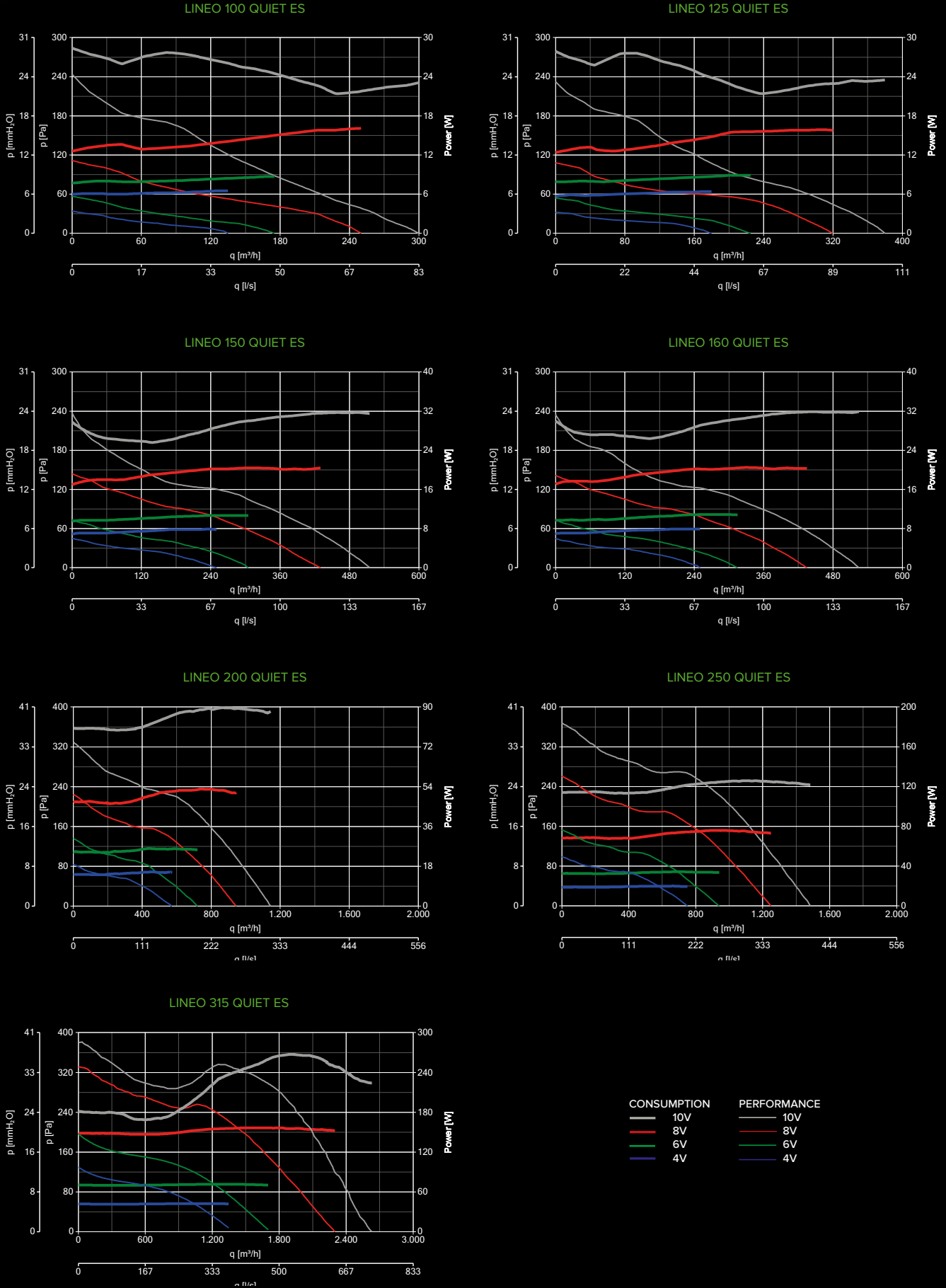

NEW

# LINEO QUIET ES RANGE

In-line mixed flow fans equipped with EC Brushless motors



## CONTROLLERS - LINEO QUIET ES

MODELS	DESCRIPTION	CODE	PRODUCT
	<b>POT-IT</b> - POTENTIOMETER	12826	17170 - 17171 - 17172 - 17173 - 17174 17175 - 17176
	<b>POT</b> - POTENTIOMETER	12828	17170 - 17171 - 17172 - 17173 - 17174 17175 - 17176
	<b>C TEMP</b> - THERMO SWITCH	12992	ALL PRODUCTS
	<b>C SMOKE</b> - AIR QUALITY SENSOR	12993	ALL PRODUCTS
	<b>C HCS</b> - HUMIDISTAT	12994	ALL PRODUCTS
	<b>C PIR</b> - PASSIVE INFRARED SENSOR	12998	ALL PRODUCTS
	<b>C TIMER</b> - TIMER	12999	ALL PRODUCTS

ΚΩΔΙΚΟΣ	ΠΕΡΙΓΡΑΦΗ	ΤΙΜΗ
17170	<b>LINEO 100/300 QUIET ES</b>	<b>351.00 €</b>
17171	<b>LINEO 125/380 QUIET ES</b>	<b>351.00 €</b>
17172	<b>LINEO 150/515 QUIET ES</b>	<b>384.00 €</b>
17173	<b>LINEO 160/525 QUIET ES</b>	<b>384.00 €</b>
17174	<b>LINEO 200/1145 QUIET ES</b>	<b>477.00 €</b>
17175	<b>LINEO 250/1485 QUIET ES</b>	<b>847.00 €</b>
17176	<b>LINEO 315/2630 QUIET ES</b>	<b>994.30 €</b>

(Quiet) αθουρυβο

(ES) κινητηρας χαμηλης καταναλωσης









# LINEO QUIET RANGE NEW

In-line mixed flow fans equipped with AC motors

## TECHNICAL AND PERFORMANCE DATA - LINEO QUIET

Models	Code	V~50/60 HZ	W		A		RPM		Max Airflow		Max Pressure		Max °C	KG
			min/med/max	max	min/med/max	max	min/med/max	max	m³/h	l/s	mmH <sub>2</sub> O	Pa		
LINEO 100 QUIET	17160	220-240	11	0.09	1455	150	41.7	9	88.3	45	3,8			
LINEO 100 T QUIET	17190		24	0.11	1880	200	55.6	11.5	112.8					
LINEO 125 QUIET	17161	220-240	11	0.09	1125	190	52.8	8	78.5	45	3,6			
LINEO 125 T QUIET	17191		24	0.11	1475	250	69.4	10	98.1					
LINEO 150 QUIET	17162	220-240	24	0.14	1040	255	70.8	10.5	103	55	5,4			
LINEO 150 T QUIET	17192		37	0.17	1430	350	97.2	15.5	152					
LINEO 160 QUIET	17163	220-240	24	0.14	1040	255	70.8	10.5	103	55	5,2			
LINEO 160 T QUIET	17193		37	0.17	1430	350	97.2	15.5	152					
LINEO 200 QUIET	17164	220-240	50	0.34	1880	805	223.6	20.6	202	50	8,6			
LINEO 200 T QUIET	17194		80	0.42	2380	1045	290.3	26.3	257.9					
LINEO 250 QUIET	17165	220-240	95	0.42	1640	960	266.7	20.2	198.1	50	13,4			
			125	0.55	2320	1340	372.2	30.3	297.2					
LINEO 315 QUIET	17166	220-240	215	0.95	1930	2070	575	30.6	300.1	50	28,3			
			270	1.15	2360	2530	702.8	43.3	424.6					
			360	1.55	2705	2890	802.8	53.6	525.7					

## SOUNDS LEVELS - LINEO QUIET

Calculated in free field conditions at 3 m distance

Models	Code	SOUND LEVEL Lw dB (A)								
		INTAKE			SUPPLY			IRRADIATED		
		min	med.	max	min	med.	max	min	med.	max
LINEO 100 QUIET	17160									
LINEO 100 T QUIET	17190	62.2	70.5	74.6	62.3	68.7	74.4	36.2	41.8	46.6
LINEO 125 QUIET	17161									
LINEO 125 T QUIET	17191	60.1	64.2	70.4	60.5	64.2	70.9	36.2	41.8	45.5
LINEO 150 QUIET	17162									
LINEO 150 T QUIET	17192	60.3	68.2	77.3	62.1	67.7	76	38.2	43.4	51.2
LINEO 160 QUIET	17163									
LINEO 160 T QUIET	17193	60.3	68.2	77.3	62.1	67.7	76	38.2	43.4	51.2
LINEO 200 QUIET	17164									
LINEO 200 T QUIET	17194	76.9	83.3	86.4	75.1	81.5	85	51.6	57.4	60.7
LINEO 250 QUIET	17165									
		76.3	83.6	85.1	75	83.4	87.4	49.5	57	60.7
LINEO 315 QUIET	17166									
		82.8	87	91.7	82.8	87	89.8	58.8	62.9	65.9

### SOUND PRESSURE LP dB(A)

Models	Code	SOUND PRESSURE LP dB(A)								
		INTAKE			SUPPLY			IRRADIATED		
		min	med.	max	min	med.	max	min	med.	max
LINEO 100 QUIET	17160									
LINEO 100 T QUIET	17190	44.6	52.9	57.1	44.8	51.2	56.9	15.7	21.3	26.1
LINEO 125 QUIET	17161									
LINEO 125 T QUIET	17191	42.6	46.7	52.9	43	46.6	53.4	15.6	21.1	25
LINEO 150 QUIET	17162									
LINEO 150 T QUIET	17192	42.8	50.7	59.7	44.5	50.1	58.5	17.6	22.9	30.7
LINEO 160 QUIET	17163									
LINEO 160 T QUIET	17193	42.8	50.7	59.7	44.5	50.1	58.5	17.6	22.9	30.7
LINEO 200 QUIET	17164									
LINEO 200 T QUIET	17194	59.3	65.8	68.8	57.6	64	67.5	31	36.9	40.2
LINEO 250 QUIET	17165									
		58.8	67.6	71.5	57.5	65.9	69.9	29	36.5	40.1
LINEO 315 QUIET	17166									
		66.8	71	74.2	65.3	69.5	72.3	38.3	42.4	45.4

## DIMENSIONS - LINEO QUIET

Models	Code	A	B	C	Ø D	E	F	G	H	L	Ø M	N	VERSION
LINEO 100 QUIET	17160												
LINEO 100 T QUIET	17190	210	294.5	639	97	130	235	135	120	67.5	5.5	320	A
LINEO 125 QUIET	17161												
LINEO 125 T QUIET	17191	210	294.6	504.5	122	130	235	135	120	67.5	5.5	320	A
LINEO 150 QUIET	17162												
LINEO 150 T QUIET	17192	232	320.5	685	147	145	261.5	170	132	85	5.5	360	A
LINEO 160 QUIET	17163												
LINEO 160 T QUIET	17193	232	320.5	570	156.5	145	261.5	170	135	85	5.5	360	A
LINEO 200 QUIET	17164												
LINEO 200 T QUIET	17194	322.5	417.5	625.5	194.5	195	363.5	190	120	155	5.5	510	B
LINEO 250 QUIET	17165												
LINEO 250 QUIET	17165	318	412	751.5	243	189.5	363.5	200	70	170	6.5	604.5	B
LINEO 315 QUIET	17166												
LINEO 315 QUIET	17166	415.5	496.5	940	307	244	441	309	110	255	8.5	780	B

### VERSION A

LINEO 100 QUIET - LINEO 100 T QUIET - LINEO 125 QUIET - LINEO 125 T QUIET  
LINEO 150 QUIET - LINEO 150 T QUIET - LINEO 160 QUIET - LINEO 160 T QUIET

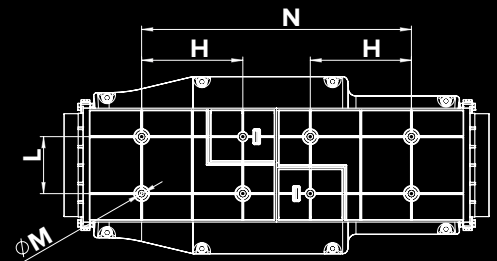
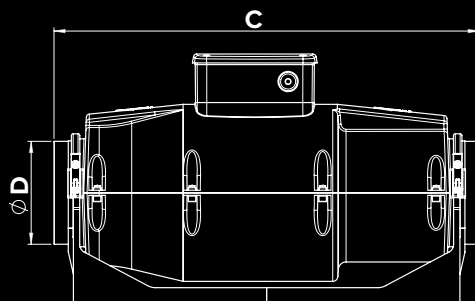
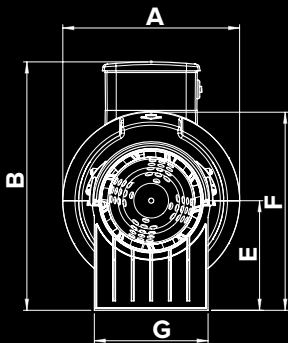

### VERSION B

LINEO 200 QUIET - LINEO 200 T QUIET - LINEO 250 QUIET - LINEO 315 QUIET

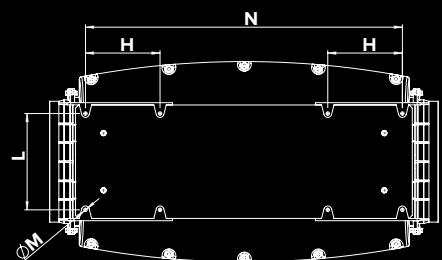
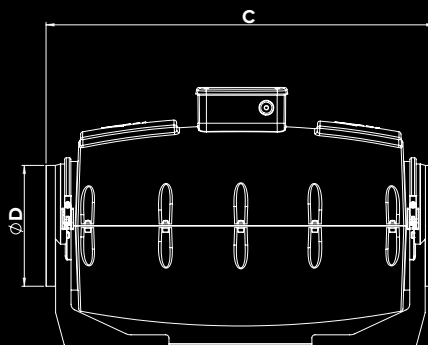
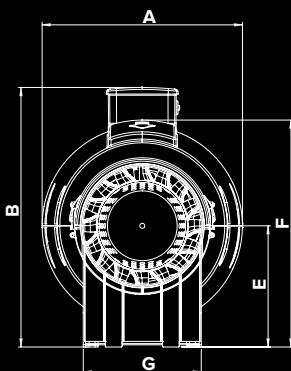



# LINEO QUIET RANGE NEW

In-line mixed flow fans equipped with AC motors

## PERFORMANCE AND ABSORPTION CURVES - LINEO QUIET

LINEO 100 QUIET - LINEO 100 T QUIET

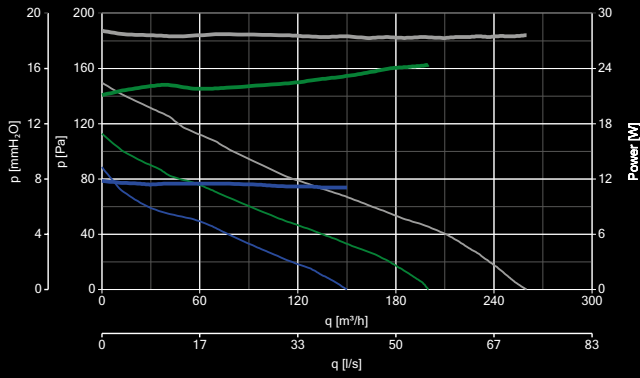

LINEO 125 QUIET - LINEO 125 T QUIET

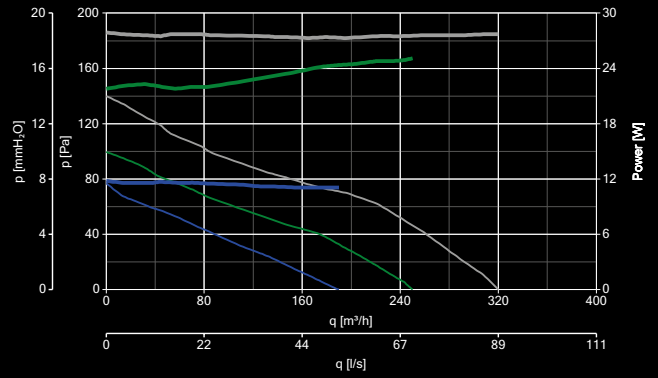

LINEO 150 QUIET - LINEO 150 T QUIET

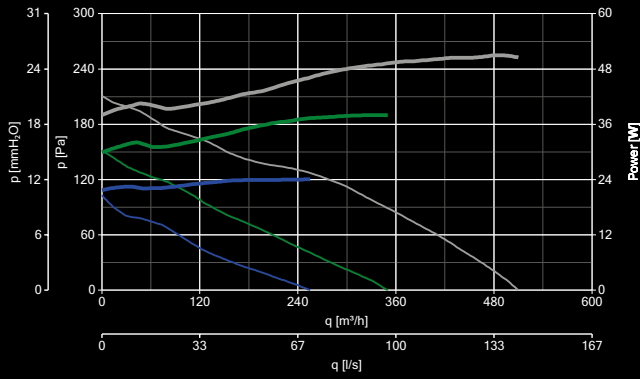

LINEO 160 QUIET - LINEO 160 T QUIET

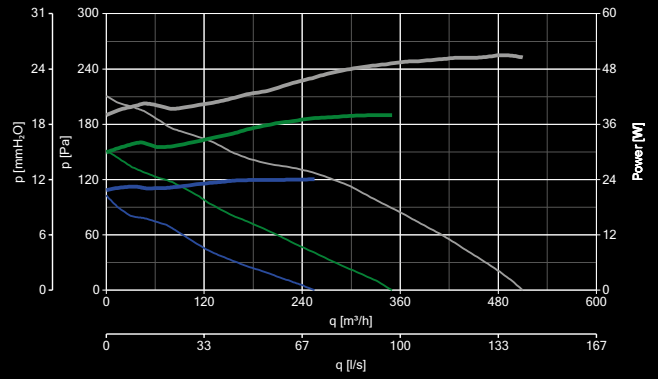

LINEO 200 QUIET - LINEO 200 T QUIET

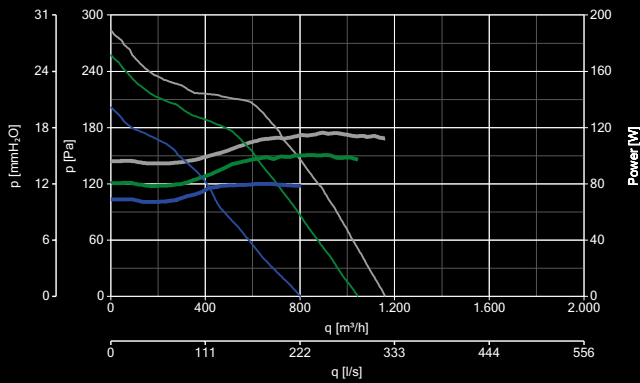

LINEO 250 QUIET

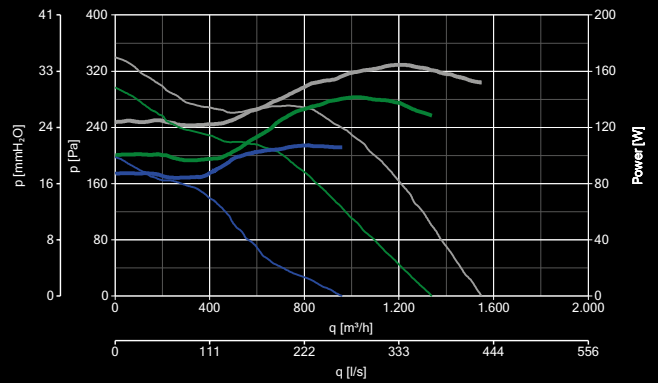



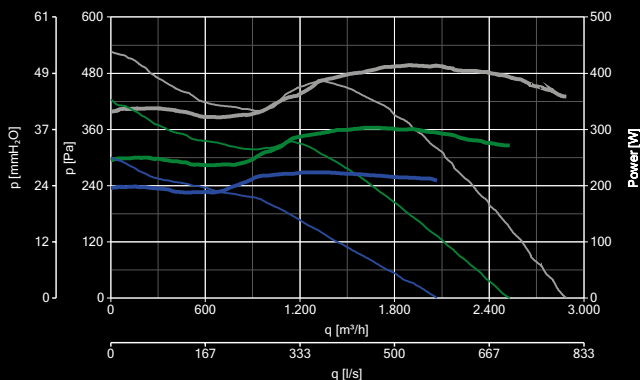

LINEO 315 QUIET



CONSUMPTION		PERFORMANCE	
—	10V	—	10V
—	6V	—	6V
—	4V	—	4V

## CONTROLLERS - LINEO QUIET

MODELS	DESCRIPTION	CODE	PRODUCT
	<b>C5 0.5</b> - 5 SPEED CONTROLLER	12987	17160 - 17161 - 17162 - 17163 - 17164 17165 - 17166
	<b>C 1.5</b> - ELECTRONIC SPEED CONTROLLER 1.5 A	12966	17160 - 17161 - 17162 - 17163 - 17164 17165 - 17166
	<b>C 2.5</b> - ELECTRONIC SPEED CONTROLLER 2.5 A	12967	17165 - 17166
	<b>KIT SCB5</b> - CONVERTS SCR5 TO A BUILT-IN VERSION	22483	12987 - 12966 - 12967
	<b>KIT SCB</b> - BUILT-IN CONTROLLER ADAPTOR	22481	12987 - 12966 - 12967
	<b>TRIO</b> - POTENTIOMETER	12891	17160 - 17161 - 17162 - 17163 - 17164 17165 - 17166 - 17190 - 17191 17192 17193 - 17194
	<b>C TEMP</b> - THERMO SWITCH	12992	ALL PRODUCTS
	<b>C SMOKE</b> - AIR QUALITY SENSOR	12993	ALL PRODUCTS
	<b>C HCS</b> - HUMIDISTAT	12994	ALL PRODUCTS
	<b>C PIR</b> - PASSIVE INFRARED SENSOR	12998	ALL PRODUCTS
	<b>C TIMER</b> - TIMER	12999	ALL PRODUCTS

ΚΩΔΙΚΟΣ	ΠΕΡΙΓΡΑΦΗ	ΤΙΜΗ
17160	<b>LINEO 100/260 QUIET</b>	<b>119.60 €</b>
17190	<b>LINEO 100/260 T QUIET</b>	<b>139.10 €</b>
17161	<b>LINEO 125/320 QUIET</b>	<b>163.20 €</b>
17191	<b>LINEO 125/320 T QUIET</b>	<b>187.00 €</b>
17162	<b>LINEO 150/510 QUIET</b>	<b>215.90 €</b>
17192	<b>LINEO 150/510 T QUIET</b>	<b>226.10 €</b>
17163	<b>LINEO 160/510 QUIET</b>	<b>215.90 €</b>
17193	<b>LINEO 160/510 T QUIET</b>	<b>226.10 €</b>
17164	<b>LINEO 200/1160 QUIET</b>	<b>278.24 €</b>
17194	<b>LINEO 200/1160 T QUIET</b>	<b>321.16 €</b>
17165	<b>LINEO 250/1550 QUIET</b>	<b>674.90 €</b>
17166	<b>LINEO 315/2890 QUIET</b>	<b>790.50 €</b>

**(Quiet)** αθουρυβο

**(T)** χρονδιακοπτης

**(AC)** κινητηρας





# LINEO RANGE

In-line mixed flow fans

The LINEO range products are fitted with 3-speed induction motors.

THE BEST COMPROMISE BETWEEN  
PERFORMANCE, POWER CONSUMPTION  
AND NOISE EMISSIONS.





# OPTIMUM EASE AND FLEXIBILITY OF INSTALLATION

## STRENGTHS

- Complete range, 26 models with a nominal diameter between 100 mm and 315 mm, 18 equipped with AC motors and 8 equipped with brushless EC motors.
- With or without timer and silenced.
- Flexibility and ease of installation ideal for your specific performance-related plant requirements, consumption needs and operating costs.



easy

# MAINTENANCE

**ELECTRIC BOX**  
Produced in a material  
granting electrical and  
fire resistance

**INLET NOZZLE**  
Dimensioned to sustain  
the product in the wall and  
ceiling installation

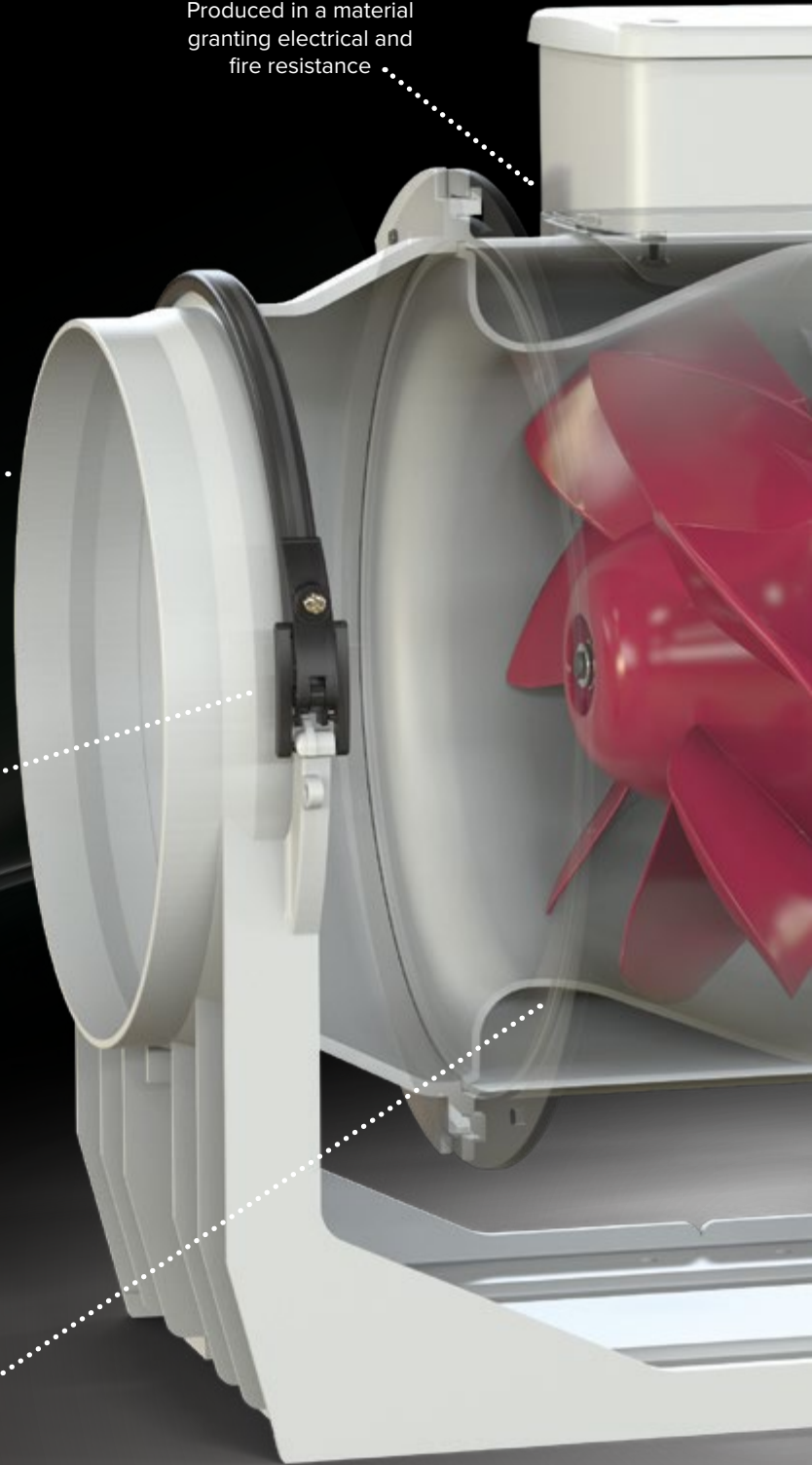

**DIVERGENT ELEMENT**  
It helps the impeller to increase  
the performance

NEW

LINEO RANGE

In-line mixed flow fans



#### IMPELLER

Passive sound dampener used to decreased the noise levels at predetermined frequencies

#### PROTECTIVE COVER

It corrects the airflow after the impeller and the rectifier, avoiding energy losses due to vortexes

#### OUTLET NOZZLE

Dimensioned to sustain the product in the wall and ceiling installation

#### RECTIFIER BLADES

Designed with the impeller to rectify the airflow and avoid flow problems on the downstream part of the product

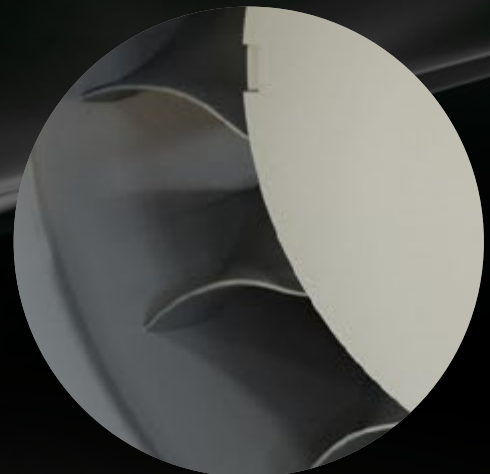
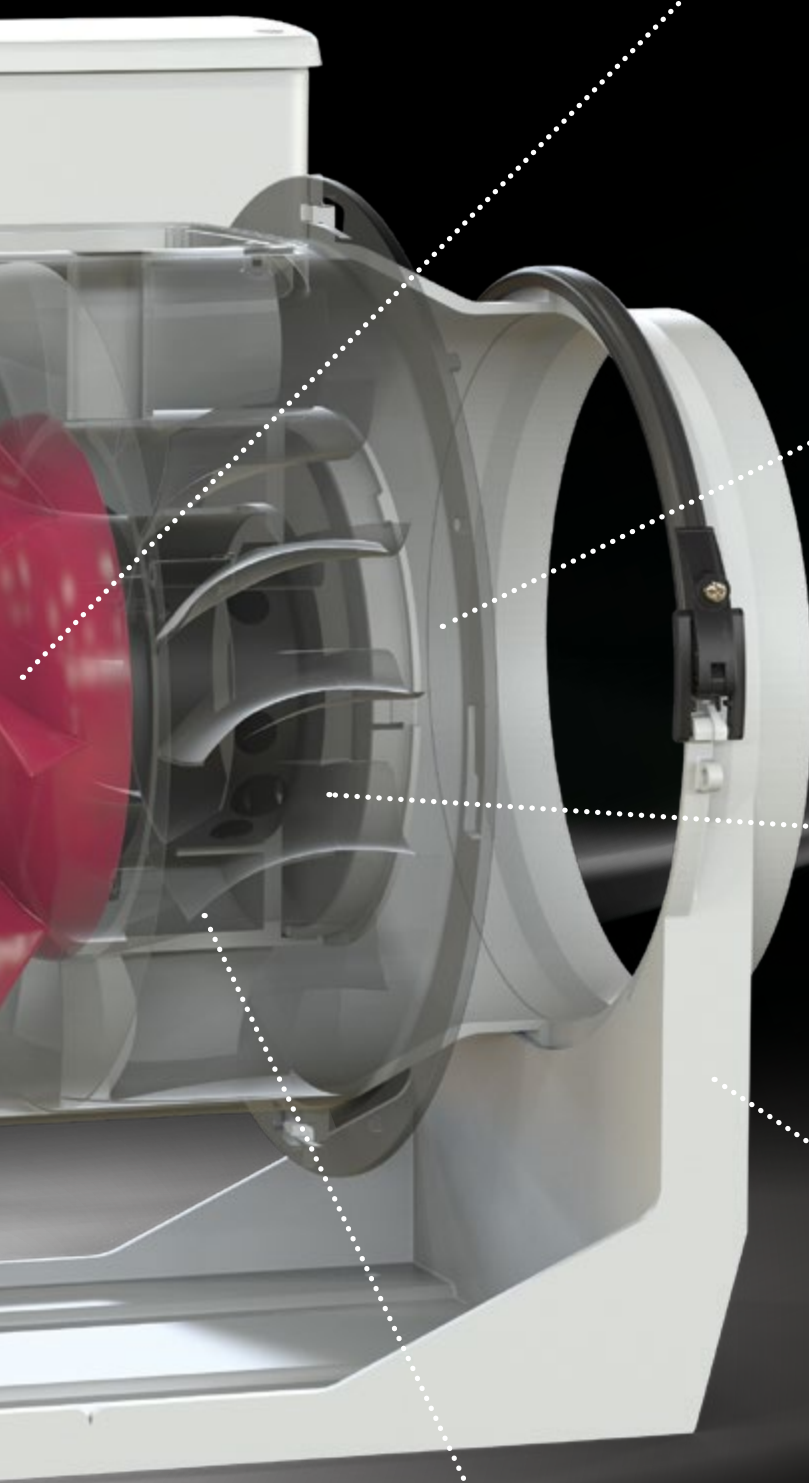



# LINEO RANGE

NEW

In-line mixed flow fans equipped with AC motors

## TECHNICAL AND PERFORMANCE DATA - LINEO

Models	Code	V 50/60HZ	W (50HZ) min/max	W (60HZ) min/max	A min/max	RPM min/max	Max Airflow		Max Pressure		Sound Pressure Lp dB (A)*	Max °C (50HZ)	Max °C (60HZ)	KG
							m³/h min/max	l/s min/max	mmH₂O min/max	Pa min/max				
LINEO 100	17144	220-240	20	22	0.09	1860	180	50	13	127.5	30.7	60	50	1.8
LINEO 100 T	17185		23	23	0.11	2450	255	70.8	16.5	161.9	39.4			
LINEO 100 Q	17143	220-240	12	15	0.09	1860	155	43.1	6.5	63.8	29.4	60	50	1.8
LINEO 100 Q T	17184		15	20	0.11	2450	200	55.6	7.5	73.6	37.9			
LINEO 125	17145	220-240	25	33	0.11	1570	250	69.4	13	127.5	33.9	60	50	1.8
LINEO 125 T	17186		33	36	0.15	2140	365	101.4	17	166.8	43			
LINEO 150	17146	220-240	40	58	0.18	1580	385	106.9	21	206	41.4	60	50	2.4
LINEO 150 T	17187		58	58	0.26	2100	550	152.8	27	264.9	50.5			
LINEO 160	17147	220-240	40	58	0.18	1580	385	106.9	21	206	41.4	60	50	2.4
LINEO 160 T	17188		58	58	0.26	2100	550	152.8	27	264.9	50.5			
LINEO 200 Q	17148	220-240	45	45	0.22	1780	700	194.4	13	127.5	39.6	60	50	4.3
LINEO 200 Q T	17189		75	90	0.37	2740	950	263.9	29	284.5	49.0			
LINEO 250 Q	17149	220-240	85	85	0.40	1850	720	200	34	333.5	49.1	60	45	5.8
LINEO 250 Q T	17197		110	140	0.50	2550	990	275	53	519.9	56.2			

\* Calculated in free field conditions at 3 m distance

Models	Code	V ~ 50	W min/med/max	A min/med/ max	RPM min/med/max	Max Airflow		Max Pressure		Max °C	KG
						m³/h min/med/max	l/s min/med/max	mmH₂O min/med/max	Pa min/med/max		
<b>NEW</b> LINEO 200	17180	220 - 240	80	0.34	1925	815	226.4	21.5	210.9	50	4,9
<b>NEW</b> LINEO 200 T	17177		95	0.42	2450	1025	284.7	27.3	267.7		
<b>NEW</b> LINEO 250	17181	220 - 240	90	0.41	1500	725	201	13.9	136.5	50	5,3
			120	0.54	2240	1145	318	29	284.4		
			145	0.63	2730	1440	400	37.2	364.8		
<b>NEW</b> LINEO 315	17182	220 - 240	190	1.14	1770	1590	442	271	265.8	50	9,5
			260	1.57	2300	2115	588	42.2	413.9		
			360	1.60	2690	2590	719	55.4	543.3		

## SUONDS LEVELS - LINEO 200 - 250 - 315

Calculated in free field conditions at 3 m distance

Models	Code	SOUND LEVEL Lw dB (A)								
		INTAKE			SUPPLY			IRRADIATED		
		min	med.	max	min	med.	max	min	med.	max
LINEO 200	17180	80	86.4	89.5	78.6	74.9	88.2	57.4	63.7	67.5
LINEO 200 T	17177									
LINEO 250	17181	73.6	83.3	88.2	72.2	81.7	86.4	52.4	60	64
LINEO 315	17182	82.6	88.7	92	82	88.2	91.8	60.1	66.3	69.5

Models	Code	SOUND PRESSURE LP dB(A)								
		INTAKE			SUPPLY			IRRADIATED		
		min	med.	max	min	med.	max	min	med.	max
LINEO 200	17180	62.5	68.8	72	61.1	67.4	70.7	36.9	43.1	46.9
LINEO 200 T	17177									
LINEO 250	17181	56.1	65.8	70.7	54.6	64.2	68.8	31.9	39.5	43.5
LINEO 315	17182	65	71.1	74.5	64.5	70.6	74.2	39.6	45.8	49

## DIMENSIONS - LINEO

Models	Code	A	B	C	Ø D	E	F	G	H	L	Ø M	N
LINEO 100	17144	188.5	211	303	96	101.5	189	90	60	80	5.5	-
LINEO 100 T	17185	188.5	211	303	96	101.5	189	90	60	80	5.5	-
LINEO 100 Q	17143	156	174	231	96	82	152	95	51.5	47.5	4.5	-
LINEO 100 Q T	17184	156	174	231	96	82	152	95	51.5	47.5	5.5	-
LINEO 125	17145	188.5	211	258	122	101.5	189	90	60	80	5.5	-
LINEO 125 T	17186	188.5	211	258	122	101.5	189	90	60	80	5.5	-
LINEO 150	17146	214.5	234	294	146	112.5	212	110	60	80	5.5	-
LINEO 150 T	17187	214.5	234	294	146	112.5	212	110	60	80	5.5	-
LINEO 160	17147	214.5	234	272.5	156	112.5	212	110	60	80	5.5	-
LINEO 160 T	17147	214.5	234	272.5	156	112.5	212	110	60	80	5.5	-
LINEO 200	17180	270	373	396	194.5	195	330	190	120	155	5.5	-
LINEO 200 T	17177	270	373	396	194.5	195	330	190	120	155	5.5	280
LINEO 200 Q	17148	234.5	266	300	196	125.5	235	140	94	100	5.5	-
LINEO 200 Q T	17189	234.5	266	300	196	125.5	235	140	94	100	5.5	-
LINEO 250	17181	300	378	322	243	190	329	200	70	170	5.5	174.5
LINEO 250 Q	17149	300	322	385	247	152.5	292	176.5	140	145	5.5	-
LINEO 250 Q T	17189	300	322	385	247	152.5	292	176.5	140	145	5.5	174.5
LINEO 315	17182	373	446	420	307	224	398	309	110	255	8.5	259.5

## VERSION A

LINEO 100 - LINEO 100 T - LINEO 125 - LINEO 125 T - LINEO 150 - LINEO 150 T  
 LINEO 160 - LINEO 160 T - LINEO 200 Q - LINEO 200 Q T - LINEO 250 Q - LINEO 250 Q T

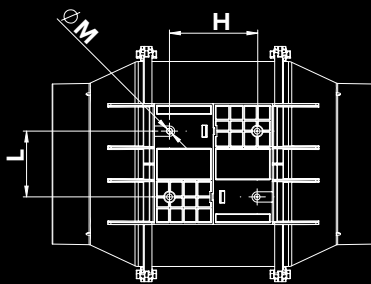

## VERSION B

LINEO 100 Q  
 LINEO Q T

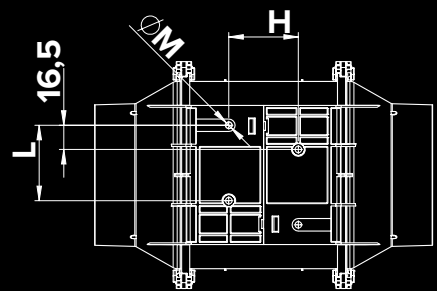

## VERSION C

LINEO 200 - LINEO 200 T - LINEO 250 - LINEO 315

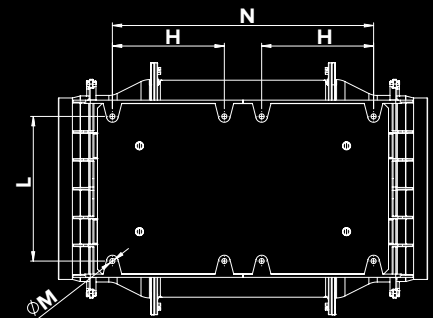
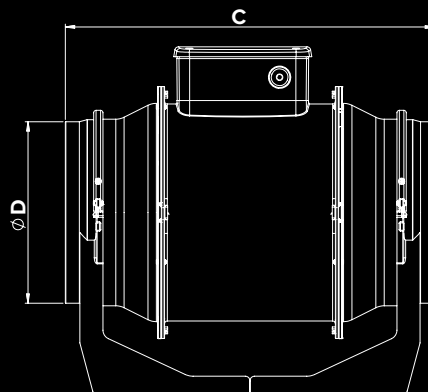
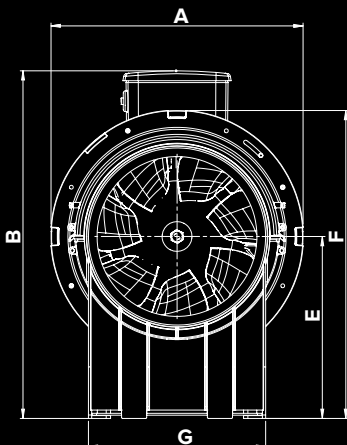



# LINEO RANGE NEW

In-line mixed flow fans equipped with AC motors

## PERFORMANCE AND ABSORPTION CURVES - LINEO

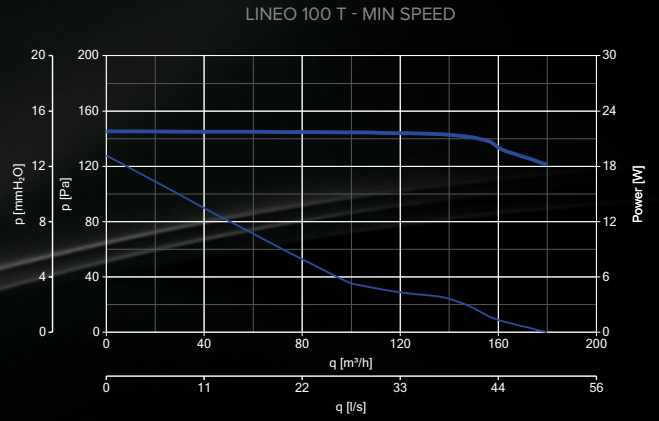
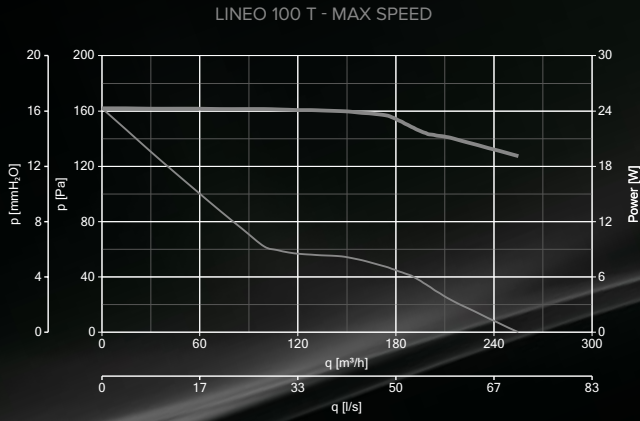
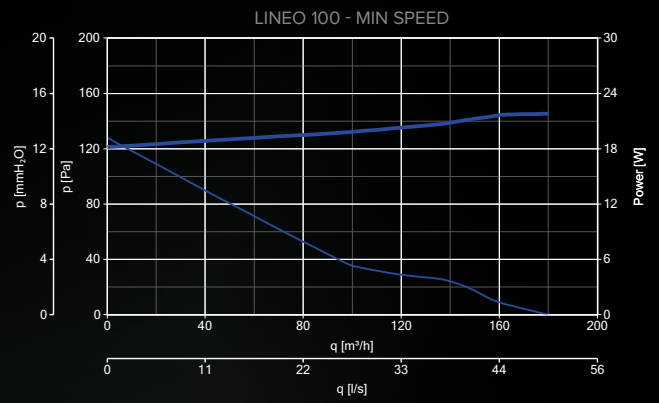
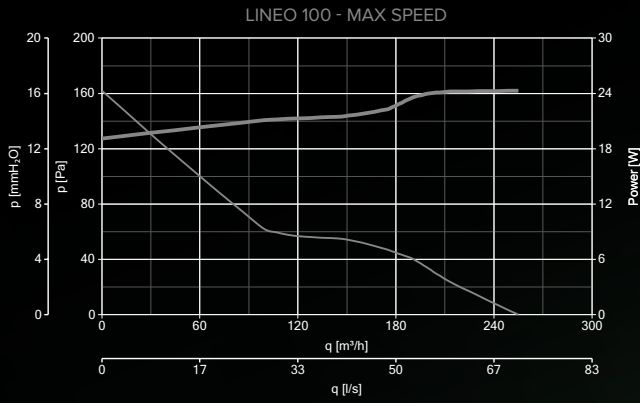

CONSUMPTION  
— max  
— min

PERFORMANCE  
— max  
— min

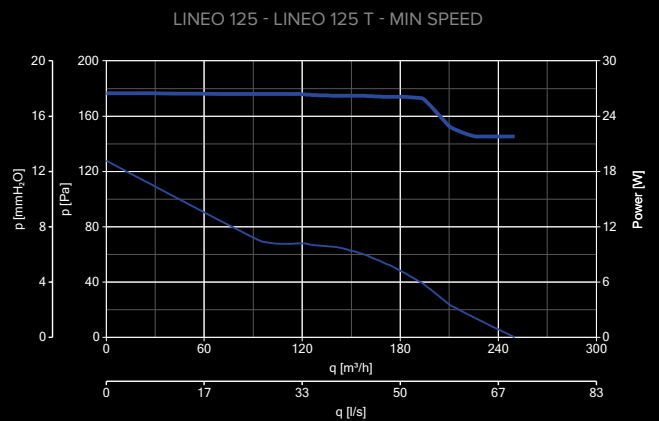
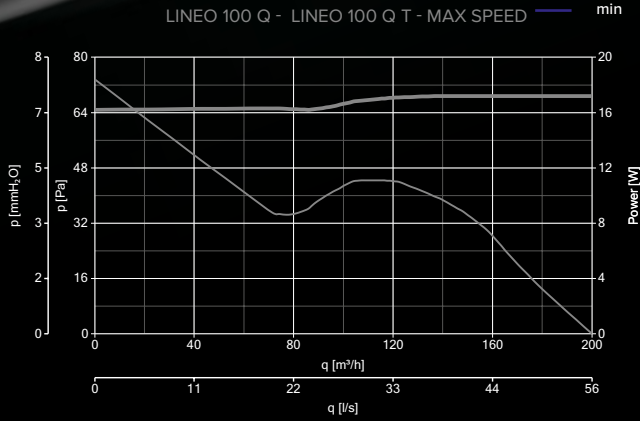

NEW

LINEO RANGE

In-line mixed flow fans equipped with AC motors



PERFORMANCE AND ABSORPTION CURVES - LINEO

LINEO 150 - LINEO 150 T - MAX SPEED

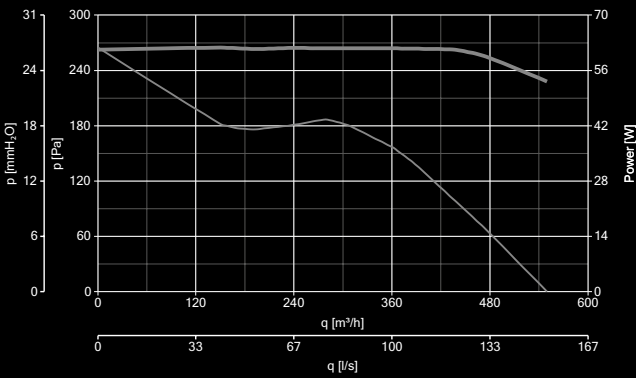

LINEO 150 - LINEO 150 T - MIN SPEED

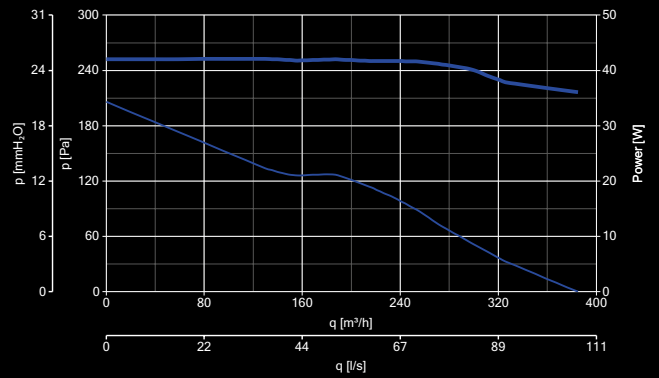

LINEO 160 - LINEO 160 T - MAX SPEED

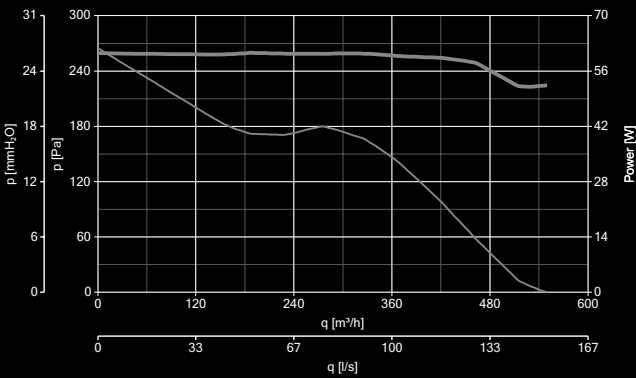

LINEO 160 - LINEO 160 T - MIN SPEED

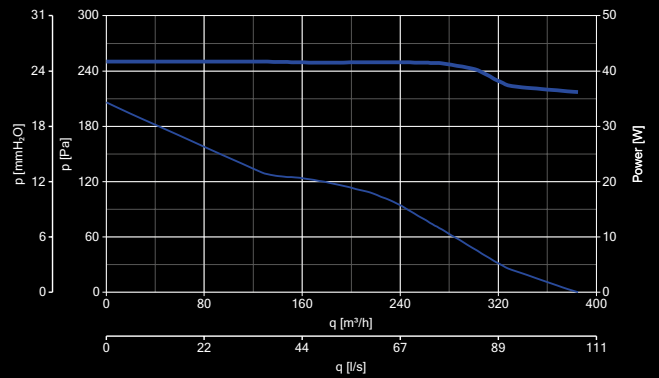

CONSUMPTION  
 — max  
 — min

PERFORMANCE  
 — max  
 — min

LINEO 200 Q - LINEO 200 Q T - MAX SPEED

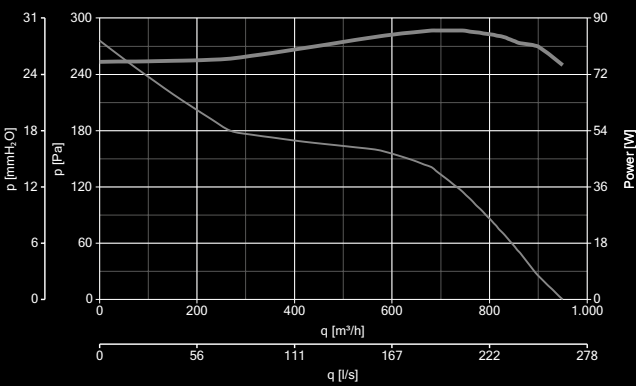

LINEO 200 Q - LINEO 200 Q T MIN SPEED

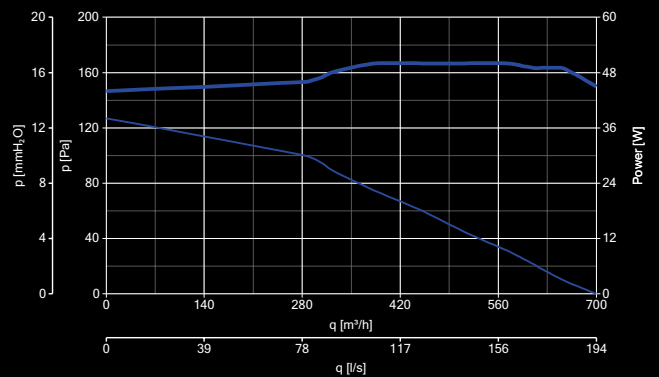

LINEO 250 Q - LINEO 250 Q T - MAX SPEED

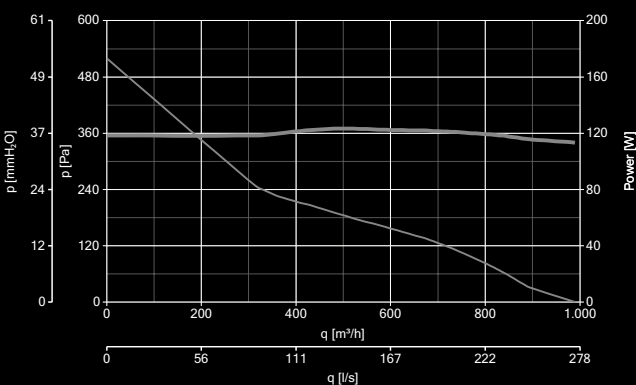

LINEO 250 Q - LINEO 250 Q T - MAX SPEED

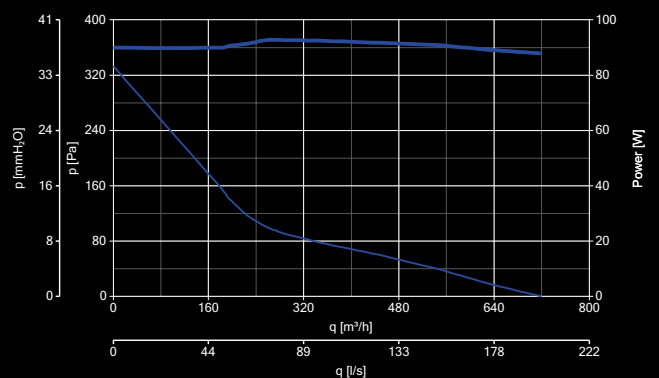

## PERFORMANCE AND ABSORPTION CURVES - LINEO

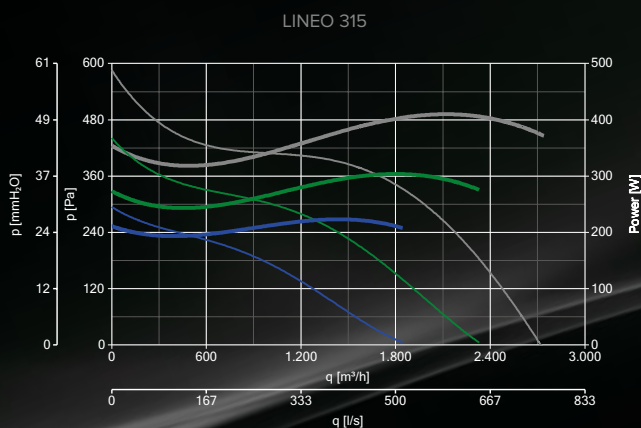
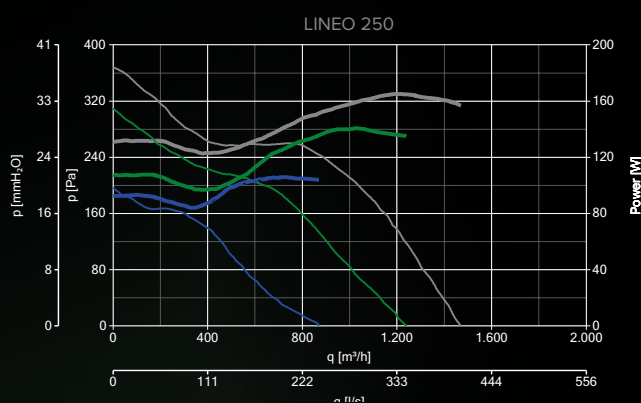
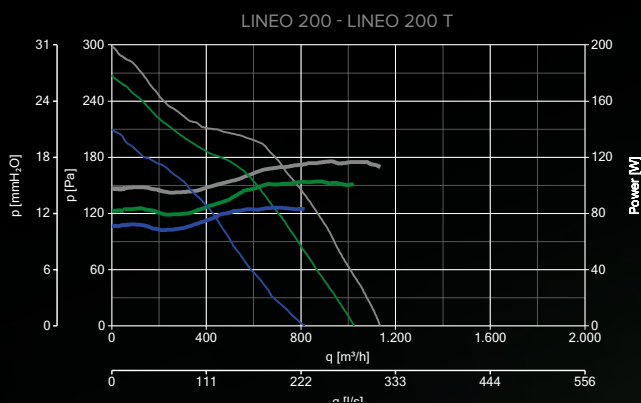

CONSUMPTION      PERFORMANCE  
 — MAX              — MAX  
 — MID              — MID  
 — MIN              — MIN

ΚΩΔΙΚΟΣ	ΠΕΡΙΓΡΑΦΗ	ΤΙΜΗ
17143	LINEO 100/200 Q	89.70 €
17184	LINEO 100/200 Q T	109.20 €
17144	LINEO 100/255	124.60 €
17185	LINEO 100/255 T	135.80 €
17145	LINEO 125/365	136.50 €
17186	LINEO 125/365 T	148.50 €
17146	LINEO 150/550	166.50 €
17187	LINEO 150/550 T	178.50 €
17147	LINEO 160/550	166.50 €
17188	LINEO 160/550 T	178.50 €
17148	LINEO 200/950 Q	175.50 €
17189	LINEO 200/950 Q T	202.50 €
17180	LINEO 200/1135	208.50 €
17177	LINEO 200/1135 T	238.50 €
17149	LINEO 250/990 Q	307.70 €
17197	LINEO 250/990 Q T	345.10 €
17181	LINEO 250/1440	348.20 €
17182	LINEO 315/2590	424.90 €

(Quiet) αθουρβο  
 (Q) Μικρης αποδοσης

(T) χρονοδιακοπτης  
 (AC) κινητηρας



NEW

# LINEO RANGE

In-line mixed flow fans equipped with AC motors

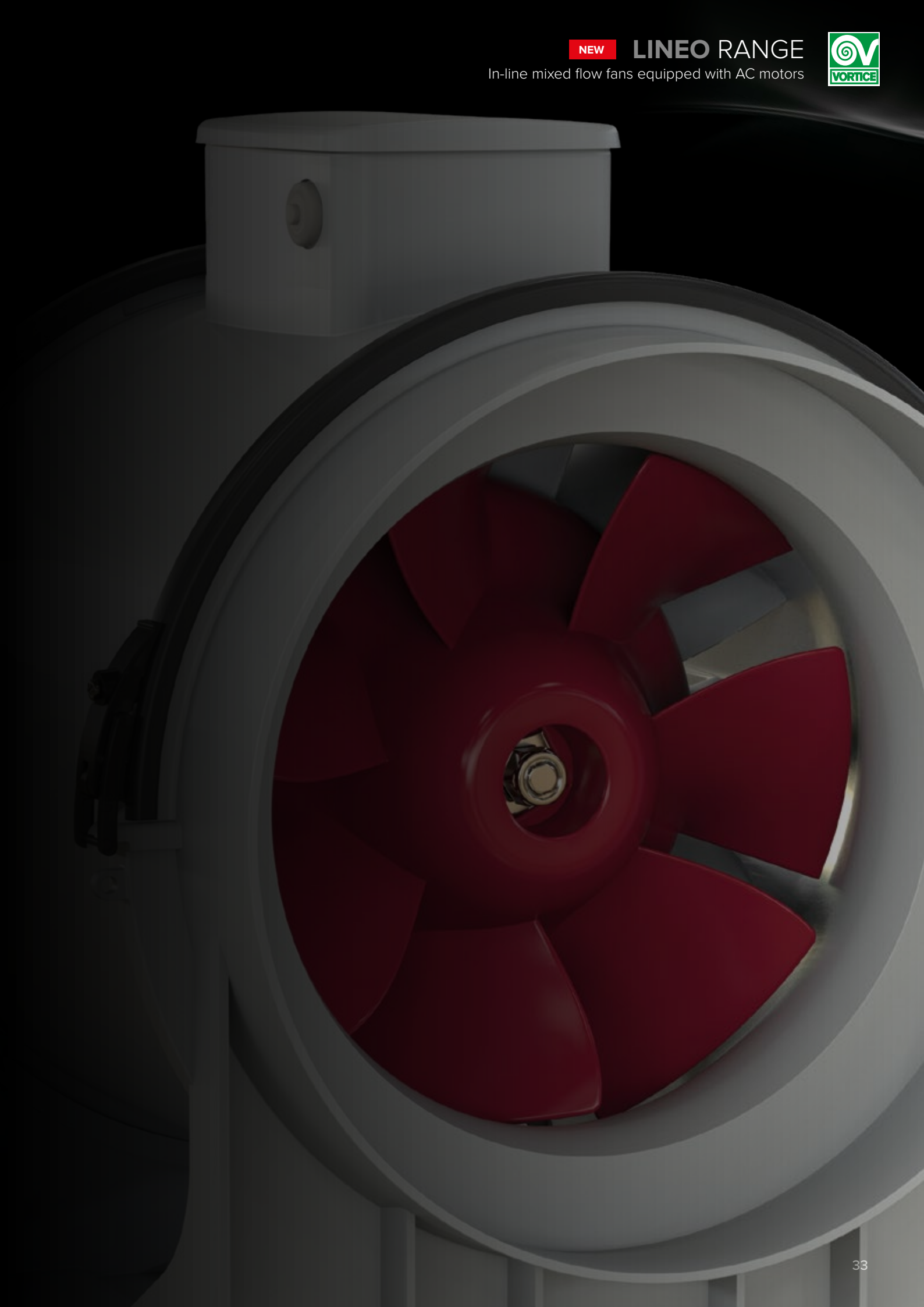



# LINEO ES RANGE NEW

In-line mixed flow fans equipped with EC Brushless motors

## TECHNICAL AND PERFORMANCE DATA - LINEO ES

Models	Code	V ~ 50/60HZ	W		A		RPM		Max Airflow		Max Pressure		Max °C	KG
			4/6/8/10V	4/6/8/10V	4/6/8/10V	4/6/8/10V	m³/h	l/s	mmH₂O	Pa				
			4/6/8/10V	4/6/8/10V	4/6/8/10V	4/6/8/10V	4/6/8/10V	4/6/8/10V	4/6/8/10V	4/6/8/10V				
LINEO 100 ES	17159	50HZ 220 - 240	6.5	0.07	1070	140	38.9	3.7	36.3	60	2.3			
			8.7	0.09	1345	175	48.6	6.1	59.8					
			16	0.15	1900	250	250	11.4	111.8					
			20	0.20	2220	305	84.7	26.4	258.9					
LINEO 100 Q ES	17158	220 - 240	5	0.05	1090	70	19.4	1.2	11.8	60	1.8			
			6.2	0.06	1450	105	29.2	2.3	22.6					
			10.5	0.10	2300	165	45.8	5.2	51					
			20	0.20	3435	260	72.2	15.7	154					
LINEO 125 ES	17178	220 - 240	7	0.07	1090	170	47.2	3.8	37.3	60	2.2			
			10	0.10	1395	220	61.1	6.5	63.7					
			18	0.17	1940	315	87.5	11.8	115.7					
			25	0.25	2270	370	102.8	30.2	296.2					
LINEO 150 ES	17179	220 - 240	11	0.10	2125	500	138.9	8.5	83.4	60	2.6			
			17	0.16	1595	370	102.8	13.8	135.3					
			34	0.30	1260	290	80.6	22.7	222.6					
			55	0.50	2480	590	163.9	44.2	433.5					
LINEO 160 ES	17183	220 - 2440	12	0.11	1305	300	83.3	9	9	60	2.7			
			19	0.17	1645	385	106.9	14.8	145.1					
			37	0.33	2165	510	141.7	23.5	230.5					
			60	0.55	2625	630	175	47.2	462.9					
<span style="background-color: red; color: white; padding: 2px;">NEW</span> LINEO 200 ES	17167	220 - 240	15.8	0.19	1380	560	155.6	9.2	90.2	50	4.6			
			25.7	0.28	1700	700	194.4	14.4	141.2					
			52.8	0.53	2220	920	255.6	24	235.4					
			90	0.80	2680	1100	305.6	34.9	342.4					
<span style="background-color: red; color: white; padding: 2px;">NEW</span> LINEO 250 ES	17168	220 - 240	20	0.20	2270	750	208.3	10.4	102	50	5			
			35	0.30	1695	995	276.4	16.3	159.9					
			80	0.70	1370	1245	345.8	27.8	272.6					
			125	1.00	2680	1500	416.7	40.5	397.2					
<span style="background-color: red; color: white; padding: 2px;">NEW</span> LINEO 315 ES	17169	220 - 240	45	0.38	1310	1385	384.7	14.2	139.3	50	9.2			
			75	0.64	1580	1720	477.8	21.3	208.9					
			165	1.35	2130	2300	638.9	37.7	369.7					
			220	1.75	2360	2560	711.1	42.3	414.8					

## SUONDS LEVELS - LINEO ES

Calculated in free field conditions at 3 m distance

### SOUND LEVEL Lw dB (A)

Models	Code	INTAKE				SUPPLY				IRRADIATED			
		4V	6V	8V	10V	4V	6V	8V	10V	4V	6V	8V	10V
LINEO 100 ES	17159	63.3	69.4	78.2	82.6	62.1	68.4	77.5	82	35.5	39.5	47.8	52.3
LINEO 100 Q ES	17158	57.8	64.9	75.1	85.7	54.9	64.9	73.5	85.7	35.1	37.4	47.5	56.6
LINEO 125 ES	17178	64.1	68.2	76.7	81.4	63.6	68.6	77.5	81.5	36.8	40.5	48.8	52.2
LINEO 150 ES	17179	67.9	74.6	82.1	87.9	69.6	75.2	82.1	86.4	41.5	47.8	56.1	62.5
LINEO 160 ES	17183	68.4	76.4	83.1	87.5	69.1	76	82.8	86.9	42.4	49.4	57	62.3
LINEO 200 ES	17167	78.5	83.9	86.9	89.4	77.5	82.9	85.4	88.4	55.6	60.4	62.8	65
LINEO 250 ES	17168	74.2	79.1	85.1	88.9	74.4	79.2	84.9	88.5	49.5	54.3	61.4	64
LINEO 315 ES	17169	83.1	88	90.7	92.8	80.8	88.2	88.8	90	63	64.6	65.3	68.1

### SOUND PRESSURE LP dB(A)

Models	Code	INTAKE				SUPPLY				IRRADIATED			
		4V	6V	8V	10V	4V	6V	8V	10V	4V	6V	8V	10V
LINEO 100 ES	17159	45.8	51.9	60.7	65.1	44.6	50.9	59.9	64.4	15	18.9	27.2	31.8
LINEO 100 Q ES	17158	40.2	47.3	57.6	68.2	37.3	47.4	56	68.1	14.6	16.9	27	36.1
LINEO 125 ES	17178	46.6	50.6	59.1	63.9	46	51.1	60	64	16.2	20	28.3	31.6
LINEO 150 ES	17179	50.4	57.1	64.6	70.3	52.1	57.7	64.5	68.9	21	27.2	35.5	41.9
LINEO 160 ES	17183	50.9	58.9	65.6	70	51.5	58.5	65.6	69.3	21.9	28.9	36.5	41.8
LINEO 200 ES	17167	60.9	66.4	69.4	71.9	60	65.3	67.9	70.8	35.1	39.9	42.3	44.5
LINEO 250 ES	17168	56.7	61.5	67.6	71.3	56.9	61.6	67.3	71	29	33.7	40.9	43.4
LINEO 315 ES	17169	65.6	70.4	73.2	75.3	63.3	70.6	71.2	72.4	42.5	44	44.8	47.5

NEW

# LINEO ES RANGE

In-line mixed flow fans equipped with EC Brushless motors



## DIMENSIONS - LINEO ES

Models	Code	A	B	C	Ø D	E	F	G	H	L	Ø M	N
LINEO 100 ES	17159	188.5	240	303	96	101.5	189	90	60	80	5.5	-
LINEO 100 Q ES	17158	156	205	231	96	82	152	95	51.5	47.5	4.5	-
LINEO 125 ES	17178	188.5	240	258	122	101.5	189	90	60	80	5.5	-
LINEO 150 ES	17179	214.5	265	294	146	112.5	212	110	60	80	5.5	-
LINEO 160 ES	17183	214.5	265	272.5	156	112.5	212	110	60	80	5.5	-
LINEO 200 ES	17167	270	372.5	396	194.5	195	330	190	120	155	5.5	280
LINEO 250 ES	17168	300	377.5	322	243	190	329	200	70	170	6.5	174.5
LINEO 315 ES	17169	373	506	420	307	224	398	309	110	255	8.5	259.5

### VERSION A

LINEO 100 ES - LINEO 125 ES  
LINEO 150 ES - LINEO 160 ES

### VERSION B

LINEO 100 Q ES

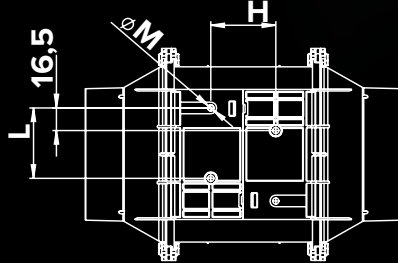
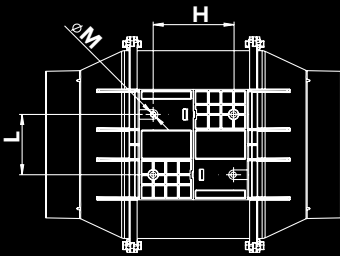

### VERSION C

LINEO 200 ES - LINEO 250 ES - LINEO 315 ES

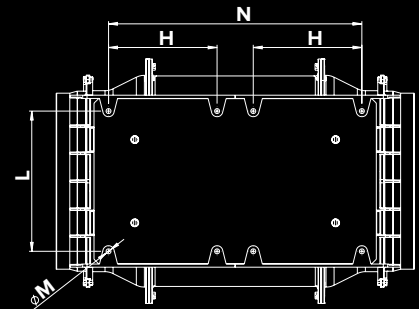
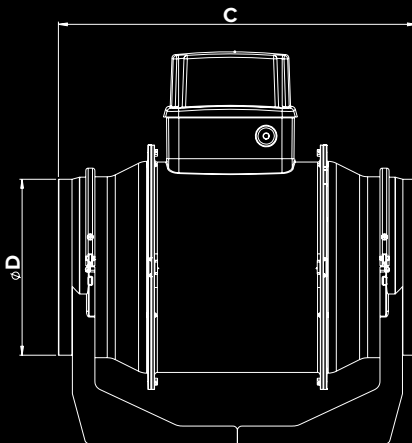
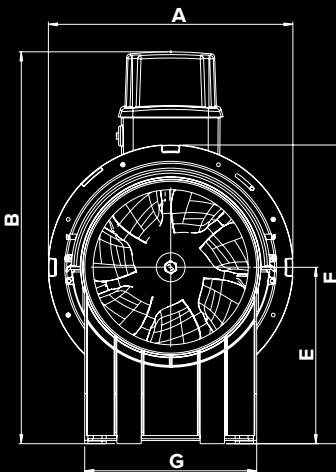



# LINEO ES RANGE





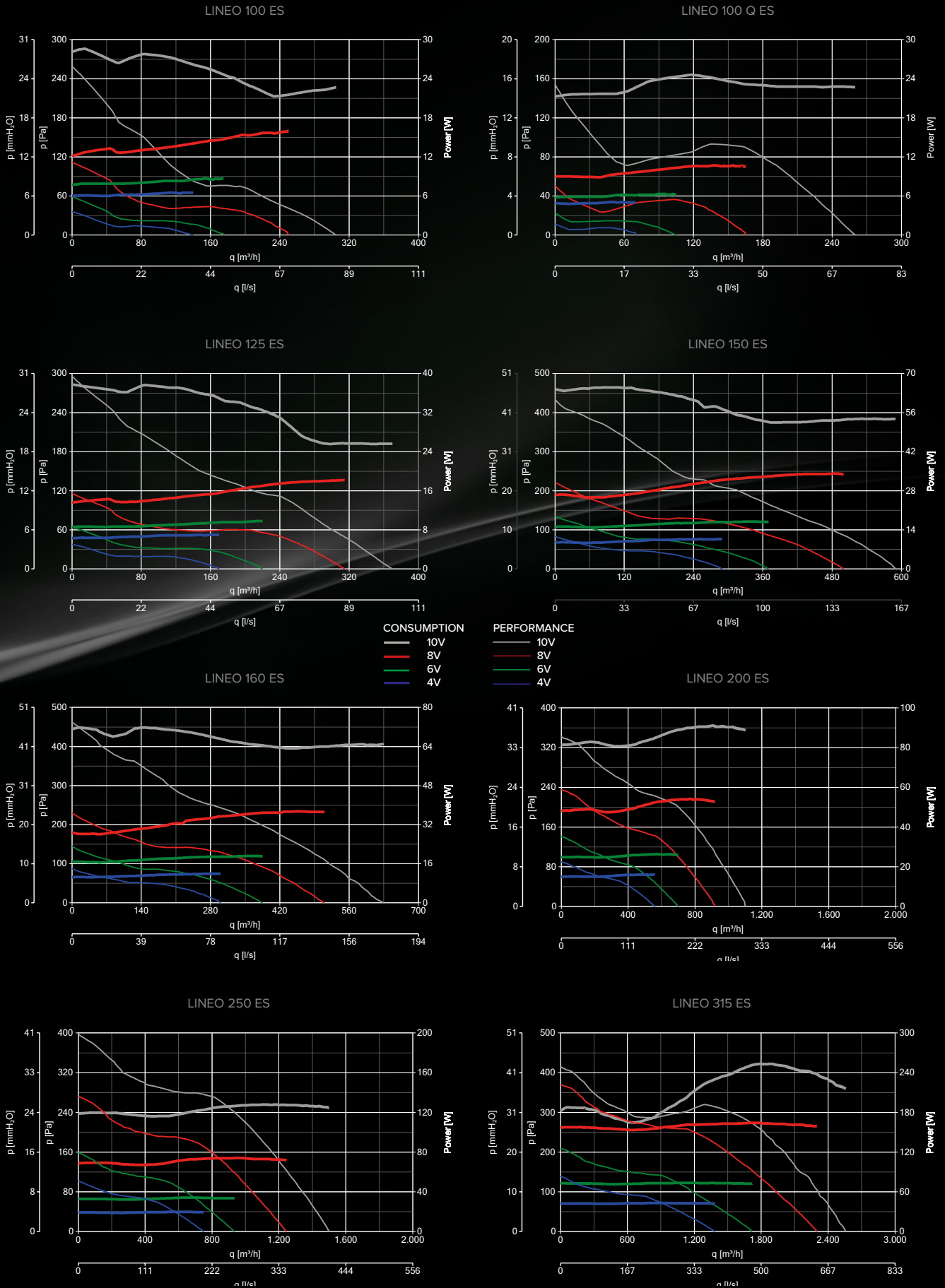

NEW

In-line mixed flow fans equipped with EC Brushless motors



## PERFORMANCE AND ABSORPTION CURVES - LINEO ES



## CONTROLLERS - LINEO

MODELS	DESCRIPTION	CODE	PRODUCT
	<b>C5 0.5</b> - 5 SPEED CONTROLLER	12987	17180
	<b>C 1.5</b> - ELECTRONIC SPEED CONTROLLER 1.5 A	12966	17180
	<b>C 2.5</b> - ELECTRONIC SPEED CONTROLLER 2.5 A	12967	17181 - 17182
	<b>KIT SCB5</b> - CONVERTS SCR5 TO A BUILT-IN VERSION	22483	12987 - 12966 - 12967
	<b>KIT SCB</b> - BUILT-IN CONTROLLER ADAPTOR	22481	12987 - 12966 - 12967
	POT-IT - POTENTIOMETER	12826	17158 - 17159 - 17179 - 17183 - 17187 17167 - 17168 - 17169
	POT - POTENTIOMETER	12828	17158 - 17159 - 17179 - 17183 - 17187 17167 - 17168 - 17169
	<b>TRIO LINEO 503</b> - 3 SPEED DIPSWITCH	12891	17181 - 17177 - 17182
	<b>C TEMP</b> - THERMO SWITCH	12992	ALL PRODUCTS
	<b>C SMOKE</b> - AIR QUALITY SENSOR	12993	ALL PRODUCTS
	<b>C HCS</b> - HUMIDISTAT	12994	ALL PRODUCTS
	<b>C PIR</b> - PASSIVE INFRARED SENSOR	12998	ALL PRODUCTS
	<b>C TIMER</b> - TIMER	12999	ALL PRODUCTS

## ACCESSORIES ON REQUEST - LINEO

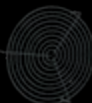
MODELS	DESCRIPTION	CODE	PRODUCT
		100	22584
	<b>LINEO-C</b> - RANGE INSTALLATION KIT	125	22585
		150	22586
		160	22587
		100	22577
	<b>LINEO-PF</b> - PARALLEL INSTALLATION KIT	125	22578
		150	22579
		160	22581
	<b>LINEO-SF 500</b> - BRACKET FOR SERIES APPLICATION	22593	
	<b>LINEO-SF 700</b> - BRACKET FOR SERIES APPLICATION	22594	17149 - 17197 - 17168 - 17169
		100	22701
		125	22702
		150	22703
		160	22704
		200	22705
		250	22706
		315	22707
			17143 - 17184 - 17144 17185 - 17159 - 17158 17145 - 17186 - 17178 17146 - 17187 - 17179 17147 - 17188 - 17183 17148 - 17189 - 17180 - 17177 - 17167 17149 - 17197 - 17168

ΚΩΔΙΚΟΣ	ΠΕΡΙΓΡΑΦΗ	ΤΙΜΗ
17159	LINEO 100/305 ES	372.80 €
17158	LINEO 100/260 Q ES	288.60 €
17178	LINEO 125/370 ES	384.50 €
17179	LINEO 150/590 ES	430.20 €
17183	LINEO 160/630 ES	310.70 €
17167	LINEO 200/1100 ES	471.20 €
17168	LINEO 250//1500 ES	616.00 €
17169	LINEO 315/2560 ES	736.00 €

(Q) Μικρης αποδοσης

(ES) κινητηρας χαμηλης καταναλωσης







Σολωμού 6,  
Γλυκά Νερά



Τηλ.: +30 210 69 25 816



info@samouris.gr



samouris.gr

## VORTICE GROUP COMPANIES

### VORTICE S.P.A

Strada Cerca, 2  
Frazione di Zoate  
20067 Tribiano  
(Milan) Italy  
Tel. (+39) 02 906991  
Fax (+39) 02 90699625  
vortice.com

### VORTICE LIMITED

Beeches House-Eastern  
Avenue Burton upon Trent  
DE13 0BB United Kingdom  
Tel. (+44) 1283 492949  
Fax (+44) 1283 544121  
vortice.ltd.uk

### VORTICE INDUSTRIAL S.R.L.

Via B. Brugnoli 3,  
37063 Isola della Scala  
(Verona) Italy  
Tel. (+39) 045 6631042  
Fax (+39) 045 6631039  
vorticeindustrial.com

### CASALS VENTILACIÓN AIR INDUSTRIAL S.L.

Ctra. Camprodon, s/n 17860  
Sant Joan de les  
Abadesses  
(Girona) Spain  
Tel. (+34) 972720150  
casals.com

### VORTICE LATAM S.A.

Bodega #6  
Zona Franca Este Alajuela,  
Alajuela 20101  
Costa Rica  
Tel. (+506) 2201 6934  
vortice-latam.com

### VORTICE VENTILATION SYSTEM

(Changzhou) Co.LTD  
No. 388 West Huanghe Road  
Building 19, Changzhou  
Post Code: 213000 China  
Tel. (+86) 0519 88990150  
Fax (+86) 0519 88990151  
vortice-china.com

The descriptions and illustrations in this catalogue are intended to be indicative and not binding. Without prejudice to the essential characteristics of the products described and illustrated here, VORTICE reserves the right to make, at any time and without notice, changes to parts, aesthetic details or supply of accessories to its products that are deemed to be appropriate for improvement or for any construction or commercial requirement.

This printout completely cancels and replaces all the previous ones

code 5.170.08 4.704 - December 2020